

Barn Doors

VersaStyle Ares, Esplanade and Rosen Series

INSTALLATION INSTRUCTIONS

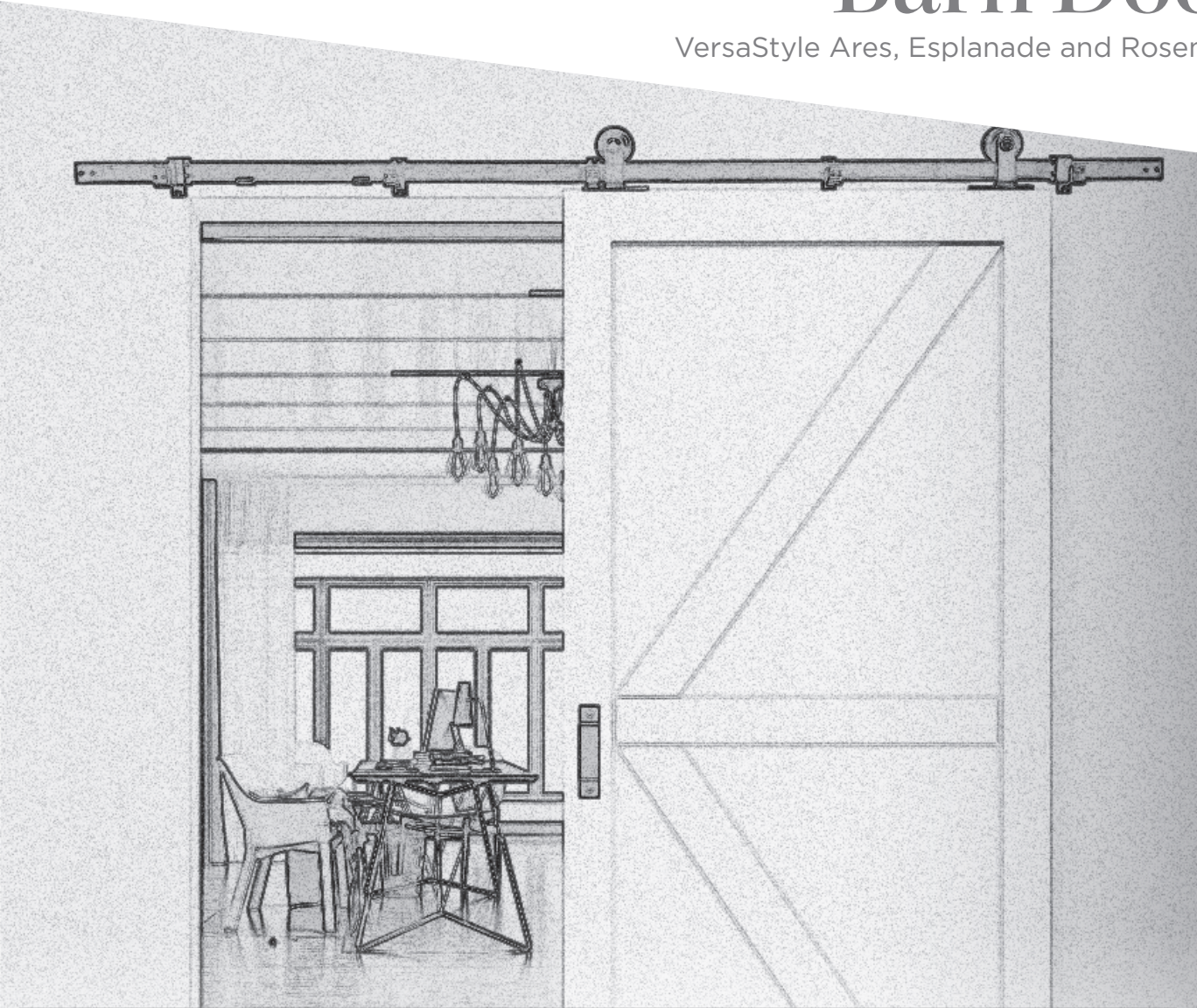

PACKAGE CONTENTS

8x



Cross Brace

4x

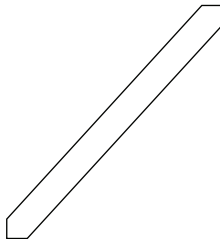

Diagonal Brace
*Rosen series only

2x



Installation Template

TOOLS REQUIRED (NOT PROVIDED)



Scissors



REQUIRES
TWO
PEOPLE

PLEASE READ CAREFULLY

- Read all instructions carefully.
- Protect your eyes by wearing safety goggles.
- Keep the installation area free of clutter.
- Follow each step completely before starting the next step.

IMPORTANT!

VERIFY THAT ALL PARTS ARE INCLUDED IN THE PACKAGING. IF ANY PARTS ARE MISSING, DO NOT RETURN THIS PRODUCT TO THE STORE.

FOR PARTS ASSISTANCE, PLEASE CALL 1-800-493-5263 BETWEEN 8:30 AM AND 4:30 PM EST, MONDAY TO FRIDAY. SUPPORT IS PROVIDED IN ENGLISH, FRENCH AND SPANISH.

PRE-ASSEMBLY

Use the provided template for correct Cross Brace placement.
No tape measure required.

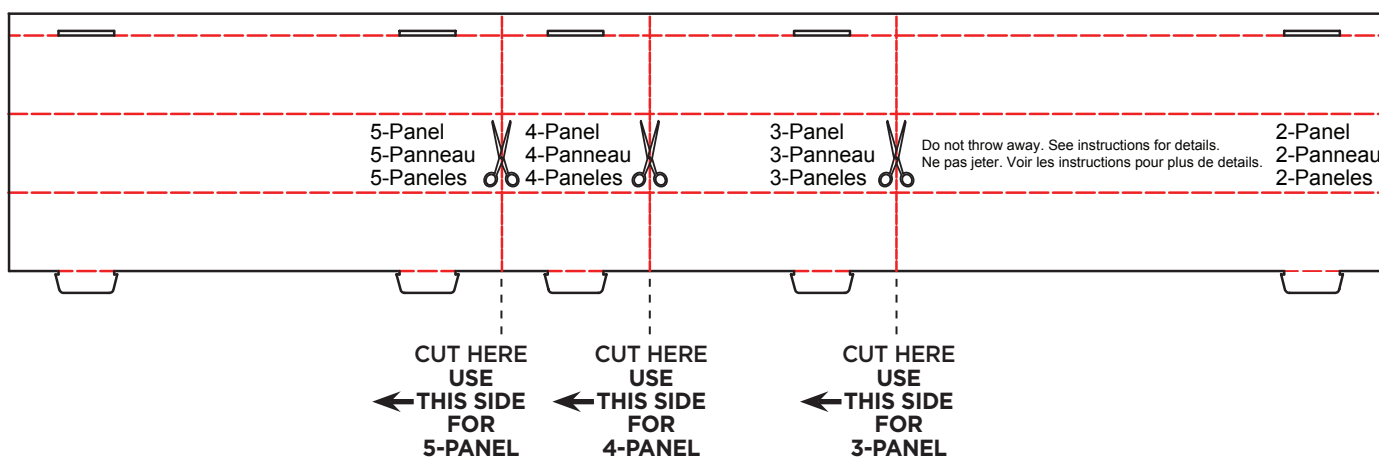

Choose your desired style* and cut the template accordingly.
For a 2-Panel design no cutting is required.

VERSASTYLE DESIGNS

*See Final page for listing of styles

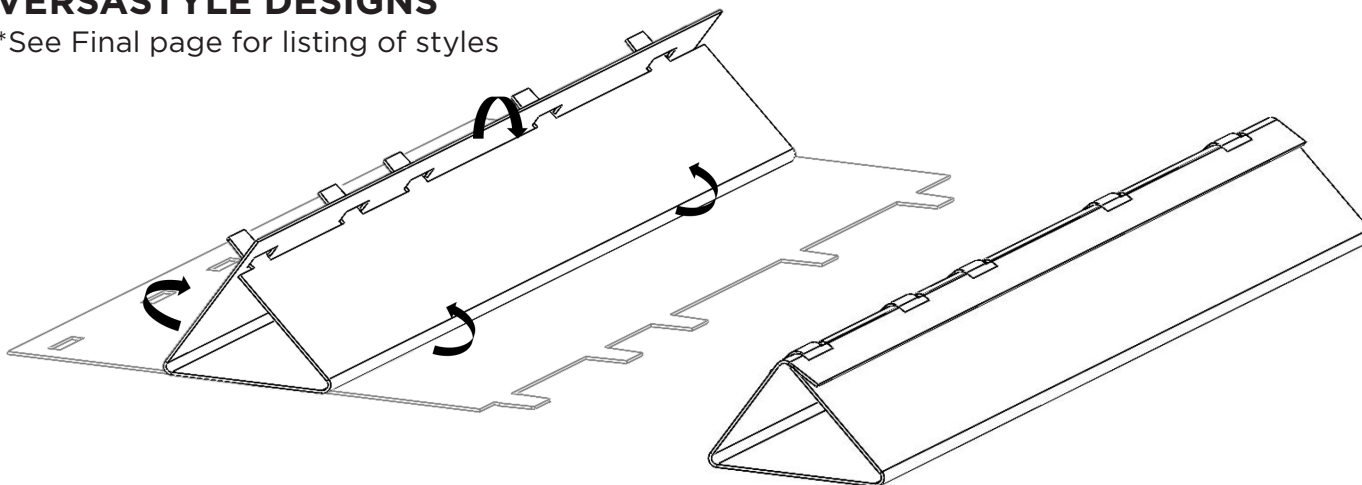

Once cut, fold the template to form a triangle. This will create a rigid template to ensure accurate placement of cross braces.

STEP 1 Installing Cross Braces

Note: Surface should be clean and dry before installing Cross Brace

Following example is a 3-panel design

- Place templates on the left and right of bottom stile
- Remove film covering the double sided tap on the back of the Cross Brace. (Fig. 2)
- Install the first Cross Brace at the end of the template

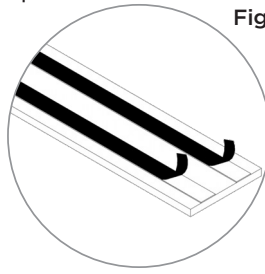
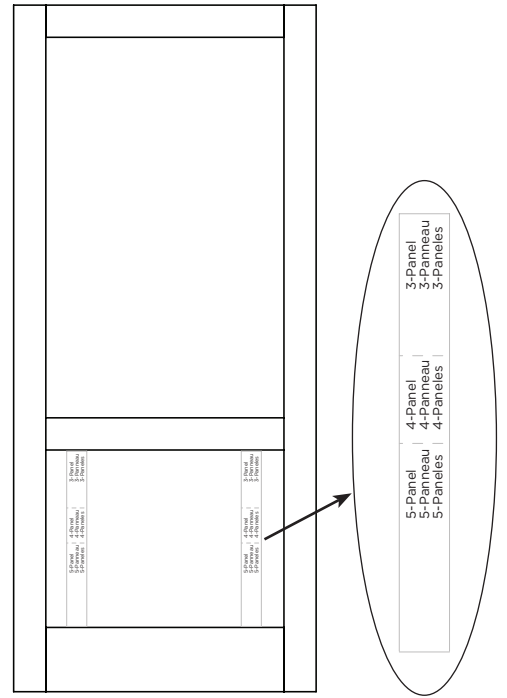

Fig. 2



If Cross Braces are too tight to fit.

- Position Cross Brace diagonally within the door frame. With Cross Brace angled pull it forward until it is straight.
- Tap the Cross Brace with your hand until it is flush with the sides of the door.

Note: Do not use a hammer to tap the Cross Brace as it may damage the wood.

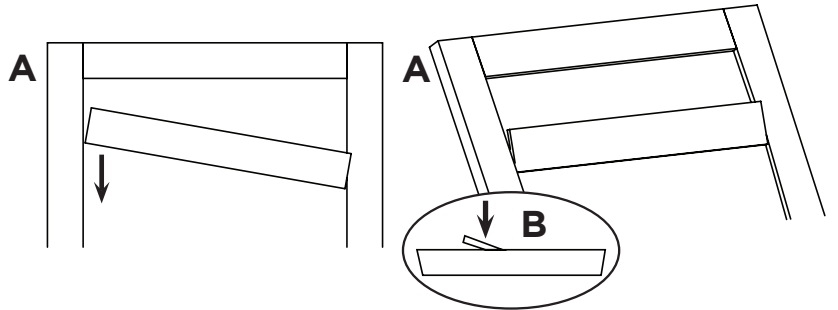

STEP 2 Installing 2nd Cross Brace

- Move templates to the top of the first installed Cross Brace and repeat Step 1

Note: Follow Steps 1 and 2 to install the Cross Braces on the opposite side of the door.

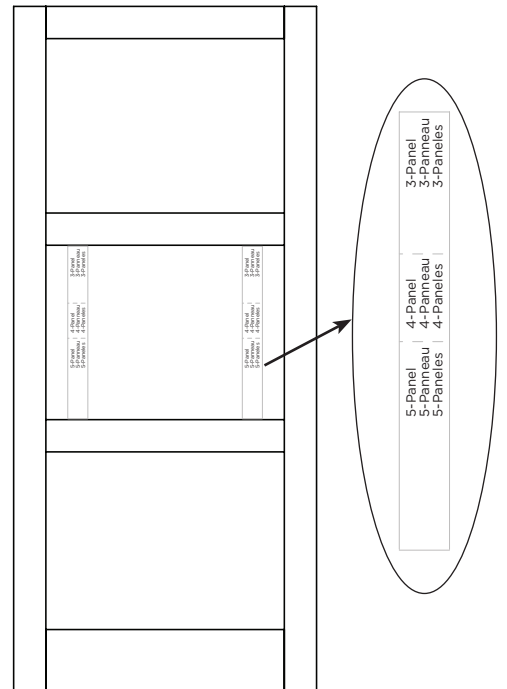

VERSASTYLE DESIGNS

DESIGN YOUR DOOR!

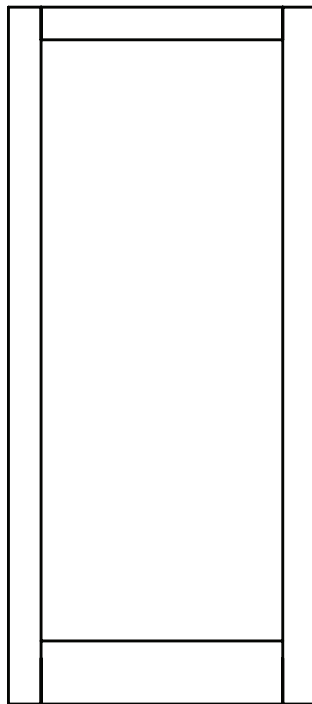

Base Slab

*Template not required

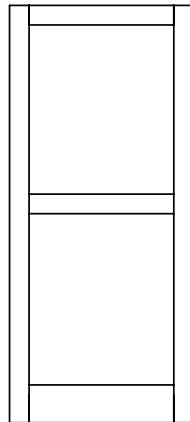

2-Panel

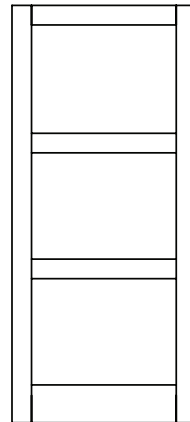

3-Panel

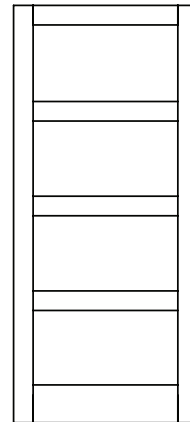

4-Panel

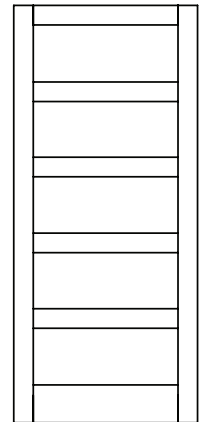

5-Panel

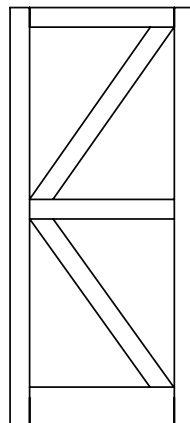

K-Design

*Template not required

Rosen series only

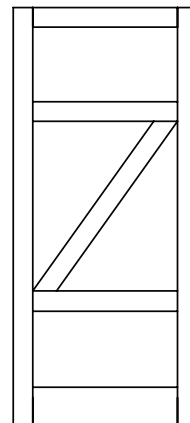

Mini Z

*Template not required

Rosen series only

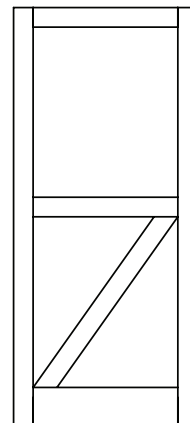

Half Check

*Template not required

Rosen series only

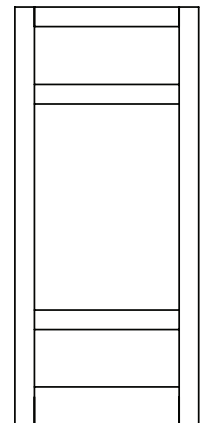

Barrel

*Template not required

5 YEAR LIMITED WARRANTY

Products warrantied against manufacturing defects for up to five years from the purchase date. The warranty applies only to the original purchaser of the product.

If a product is determined to be defective due to a manufacturing defect, a replacement product will be supplied. The scope of the warranty is limited to replacing the product and does not include labor required to install, repair or deliver, or any costs related to removing the existing product.

This warranty is void in the event that the product is damaged in transit, or if damage or failure is caused by abuse, misuse, storage of products in an improper environment, abnormal usage, faulty installation, failure to follow installation instructions, damage in an accident, improper maintenance, or any repair.

We reserve the right to inspect any claim prior to issuing credit.